



Accessory for 3KF size 3 Direct operating mechanism, red/yellow Can be locked in OFF position with three padlocks

Model	
product brand name	SENTRON
product designation	Accessories for switch disconnectors
design of the product	Direct operating mechanism
suitability for use	For 3KF size 3
color of the actuating element	red/yellow
product description	Lockable with up to 3 locks

Mechanical Design	
net weight	300 g

Certificates	
reference code	
<ul style="list-style-type: none"> according to EN 61346-2 according to IEC 81346-2 	<p>Q</p> <p>Q</p>

Approvals Certificates	
General Product Approval	Declaration of Conformity

[Confirmation](#)



[Miscellaneous](#)



Test Certificates	Marine / Shipping	other	Environment
-------------------	-------------------	-------	-------------

[Type Test Certificates/Test Report](#)



LRS

[Confirmation](#)

[Miscellaneous](#)

[Environmental Confirmations](#)

Further information

Siemens has decided to exit the Russian market (see here).
<https://press.siemens.com/global/en/pressrelease/siemens-wind-down-russian-business>

Siemens is working on the renewal of the current EAC certificates.
 Please contact your local Siemens office on the status of validity of the EAC certification if you intend to import or offer to supply these products to an EAC relevant market (other than the sanctioned EAEU member states Russia or Belarus).

Information on the packaging
<https://support.industry.siemens.com/cs/ww/en/view/109813875>

Information- and Downloadcenter (Catalogs, Brochures,...)
<http://www.siemens.com/lowvoltage/catalogs>

Industry Mall (Online ordering system)
<https://mall.industry.siemens.com/mall/en/en/Catalog/product?mlfb=3KF9301-2AA00>

Service&Support (Manuals, Certificates, Characteristics, FAQs,...)
<https://support.industry.siemens.com/cs/ww/en/ps/3KF9301-2AA00>

Image database (product images, 2D dimension drawings, 3D models, device circuit diagrams, ...)

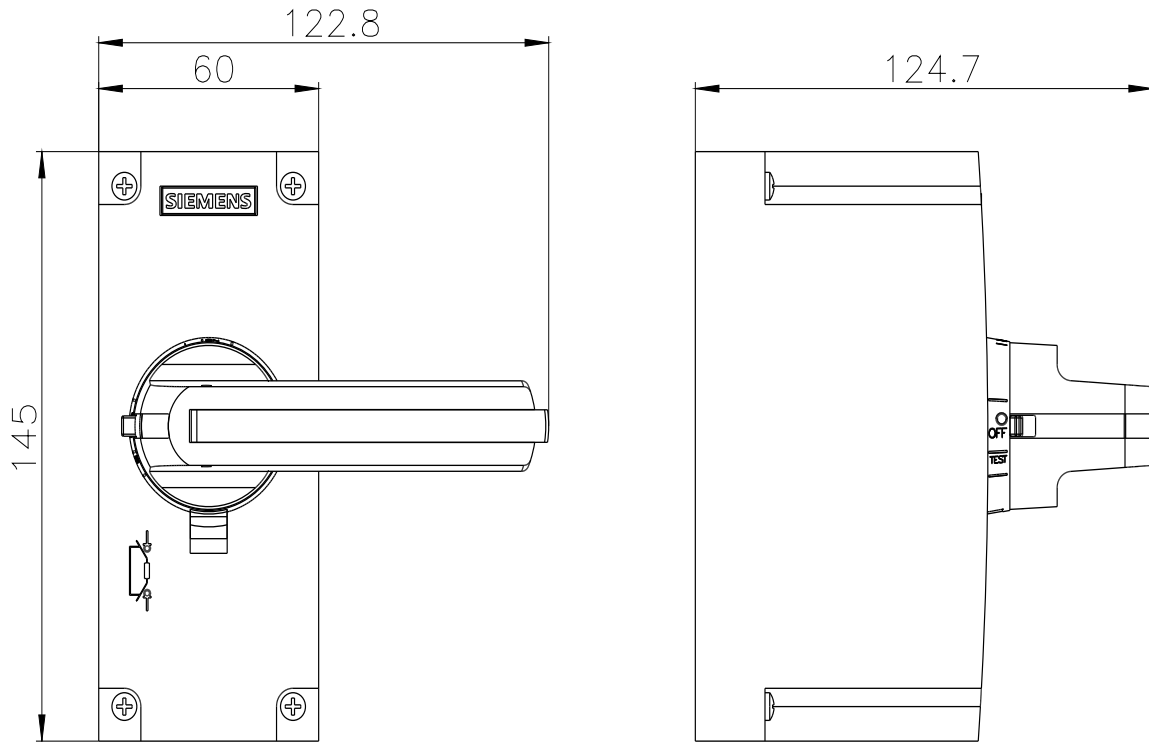

last modified:

8/19/2022 

